

Features

- Center amplifying gate
- Metal case with ceramic insulator
- International standard case TO-200AC (B-PUK)
- High profile hockey-puk

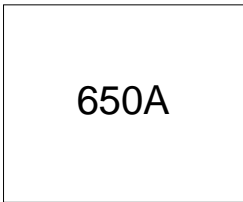

Typical Applications

- DC motor controls
- Controlled DC power supplies
- AC controllers

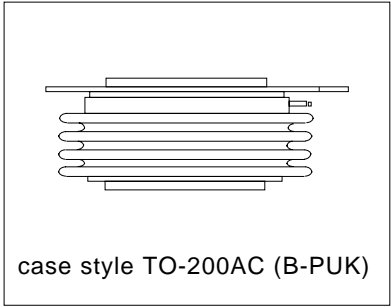

Major Ratings and Characteristics

Parameters	ST330C..L	Units
$I_{T(AV)}$	650	A
@ T_{hs}	55	°C
$I_{T(RMS)}$	1230	A
@ T_{hs}	25	°C
I_{TSM}	@ 50Hz 9000	A
	@ 60Hz 9420	A
I^2t	@ 50Hz 405	KA ² s
	@ 60Hz 370	KA ² s
V_{DRM}/V_{RRM}	400 to 2000	V
t_q typical	100	μs
T_J	- 40 to 125	°C

ST330C..L Series

Bulletin I25154 rev. D 04/03

International
IRF Rectifier

ELECTRICAL SPECIFICATIONS

Voltage Ratings

Type number	Voltage Code	V_{DRM}/V_{RRM} , max. repetitive peak and off-state voltage V	V_{RSM} , maximum non-repetitive peak voltage V	I_{DRM}/I_{RRM} max. @ $T_J = T_J$ max mA
ST2330C..L	04	400	500	50
	08	800	900	
	12	1200	1300	
	14	1400	1500	
	16	1600	1700	
	18	1800	1900	
	20	2000	2100	

On-state Conduction

Parameter	ST330C..L	Units	Conditions	
$I_{T(AV)}$ Max. average on-state current @ Heatsink temperature	650 (314)	A	180° conduction, half sine wave double side (single side) cooled	
	55 (75)	°C		
$I_{T(RMS)}$ Max. RMS on-state current	1230	A	DC @ 25°C heatsink temperature double side cooled	
I_{TSM} Max. peak, one-cycle non-repetitive surge current	9000		t = 10ms	No voltage reappplied
	9420		t = 8.3ms	100% V_{RRM}
	7570		t = 10ms	reappplied
	7920	t = 8.3ms	reappplied	
I^2t Maximum I^2t for fusing	405	KA ² s	t = 10ms	No voltage reappplied
	370		t = 8.3ms	reappplied
	287		t = 10ms	100% V_{RRM}
	262		t = 8.3ms	reappplied
$I^2\sqrt{t}$ Maximum $I^2\sqrt{t}$ for fusing	4050	KA ² /s	t = 0.1 to 10ms, no voltage reappplied	
$V_{T(TO)1}$ Low level value of threshold voltage	0.91	V	(16.7% $\times \pi \times I_{T(AV)} < I < \pi \times I_{T(AV)}$), $T_J = T_J$ max.	
$V_{T(TO)2}$ High level value of threshold voltage	0.93		($I > \pi \times I_{T(AV)}$), $T_J = T_J$ max.	
r_{t1} Low level value of on-state slope resistance	0.57	mΩ	(16.7% $\times \pi \times I_{T(AV)} < I < \pi \times I_{T(AV)}$), $T_J = T_J$ max.	
r_{t2} High level value of on-state slope resistance	0.57		($I > \pi \times I_{T(AV)}$), $T_J = T_J$ max.	
V_{TM} Max. on-state voltage	1.90	V	$I_{pk} = 1730A$, $T_J = T_J$ max, $t_p = 10ms$ sine pulse	
I_H Maximum holding current	600	mA	$T_J = 25^\circ C$, anode supply 12V resistive load	
I_L Typical latching current	1000			

Switching

Parameter	ST330C..L	Units	Conditions
di/dt Max. non-repetitive rate of rise of turned-on current	1000	A/ μs	Gate drive 20V, 20Ω, $t_r \leq 1\mu s$ $T_J = T_J$ max, anode voltage $\leq 80\% V_{DRM}$
t_d Typical delay time	1.0	μs	Gate current 1A, $di_g/dt = 1A/\mu s$ $V_d = 0.67\% V_{DRM}$, $T_J = 25^\circ C$
t_q Typical turn-off time	100		$I_{TM} = 550A$, $T_J = T_J$ max, $di/dt = 40A/\mu s$, $V_R = 50V$ $dv/dt = 20V/\mu s$, Gate 0V 100Ω, $t_p = 500\mu s$

Blocking

Parameter	ST330C..L	Units	Conditions
dv/dt Maximum critical rate of rise of off-state voltage	500	V/ μ s	$T_J = T_J \text{ max. linear to } 80\% \text{ rated } V_{\text{DRM}}$
I_{RRM} I_{DRM} Max. peak reverse and off-state leakage current	50	mA	$T_J = T_J \text{ max, rated } V_{\text{DRM}}/V_{\text{RRM}}$ applied

Triggering

Parameter	ST330C..L	Units	Conditions
P_{GM} Maximum peak gate power	10.0	W	$T_J = T_J \text{ max, } t_p \leq 5\text{ms}$
$P_{\text{G(AV)}}$ Maximum average gate power	2.0		$T_J = T_J \text{ max, } f = 50\text{Hz, } d\% = 50$
I_{GM} Max. peak positive gate current	3.0	A	$T_J = T_J \text{ max, } t_p \leq 5\text{ms}$
$+V_{\text{GM}}$ Maximum peak positive gate voltage	20	V	$T_J = T_J \text{ max, } t_p \leq 5\text{ms}$
$-V_{\text{GM}}$ Maximum peak negative gate voltage	5.0		
I_{GT} DC gate current required to trigger	TYP.	MAX.	$T_J = -40^\circ\text{C}$ $T_J = 25^\circ\text{C}$ $T_J = 125^\circ\text{C}$ Max. required gate trigger/ current/ voltage are the lowest value which will trigger all units 12V anode-to-cathode applied
	200	-	
	100	200	
V_{GT} DC gate voltage required to trigger	2.5	-	$T_J = -40^\circ\text{C}$ $T_J = 25^\circ\text{C}$ $T_J = 125^\circ\text{C}$
	1.8	3.0	
	1.1	-	
I_{GD} DC gate current not to trigger	10	mA	$T_J = T_J \text{ max}$ Max. gate current/voltage not to trigger is the max. value which will not trigger any unit with rated V_{DRM} anode-to-cathode applied
V_{GD} DC gate voltage not to trigger	0.25	V	

Thermal and Mechanical Specification

Parameter	ST330C..L	Units	Conditions
T_J Max. operating temperature range	-40 to 125	$^\circ\text{C}$	
T_{stg} Max. storage temperature range	-40 to 150		
$R_{\text{thJ-hs}}$ Max. thermal resistance, junction to heatsink	0.11	K/W	DC operation single side cooled
	0.06		DC operation double side cooled
$R_{\text{thC-hs}}$ Max. thermal resistance, case to heatsink	0.011	K/W	DC operation single side cooled
	0.005		DC operation double side cooled
F Mounting force, $\pm 10\%$	9800	N	
	(1000)	(Kg)	
wt Approximate weight	250	g	
Case style	TO-200AC (B-PUK)		See Outline Table

ST330C..L Series

Bulletin I25154 rev. D 04/03

International
IRF Rectifier

ΔR_{thJ-hs} Conduction

(The following table shows the increment of thermal resistance R_{thJ-hs} when devices operate at different conduction angles than DC)

Conduction angle	Sinusoidal conduction		Rectangular conduction		Units	Conditions
	Single Side	Double Side	Single Side	Double Side		
180°	0.012	0.010	0.008	0.008	K/W	$T_J = T_{J \text{ max.}}$
120°	0.014	0.015	0.014	0.014		
90°	0.018	0.018	0.019	0.019		
60°	0.026	0.027	0.027	0.028		
30°	0.045	0.046	0.046	0.046		

Ordering Information Table

Device Code							
ST	33	0	C	16	L	1	
①	②	③	④	⑤	⑥	⑦	⑧
1	-	Thyristor	2	-	Essential part number	3	-
3	-	0 = Converter grade	4	-	C = Ceramic Puk	5	-
5	-	Voltage code: Code x 100 = V_{RRM} (See Voltage Rating Table)	6	-	L = Puk Case TO-200AC (B-PUK)	7	-
7	-	0 = Eyelet terminals (Gate and Auxiliary Cathode Unsoldered Leads)		-	1 = Fast-on terminals (Gate and Auxiliary Cathode Unsoldered Leads)		-
	-	2 = Eyelet terminals (Gate and Auxiliary Cathode Soldered Leads)		-	3 = Fast-on terminals (Gate and Auxiliary Cathode Soldered Leads)		-
8	-	Critical dv/dt: None = 500V/ μ sec (Standard selection)		-	L = 1000V/ μ sec (Special selection)		-

Outline Table

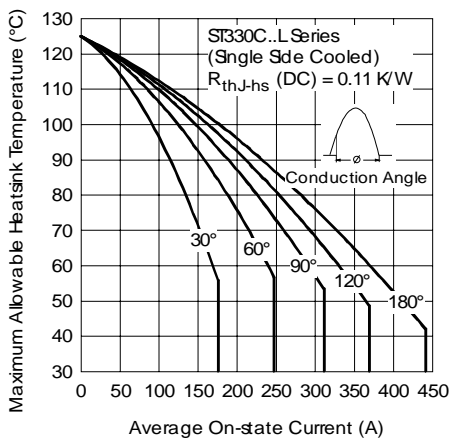
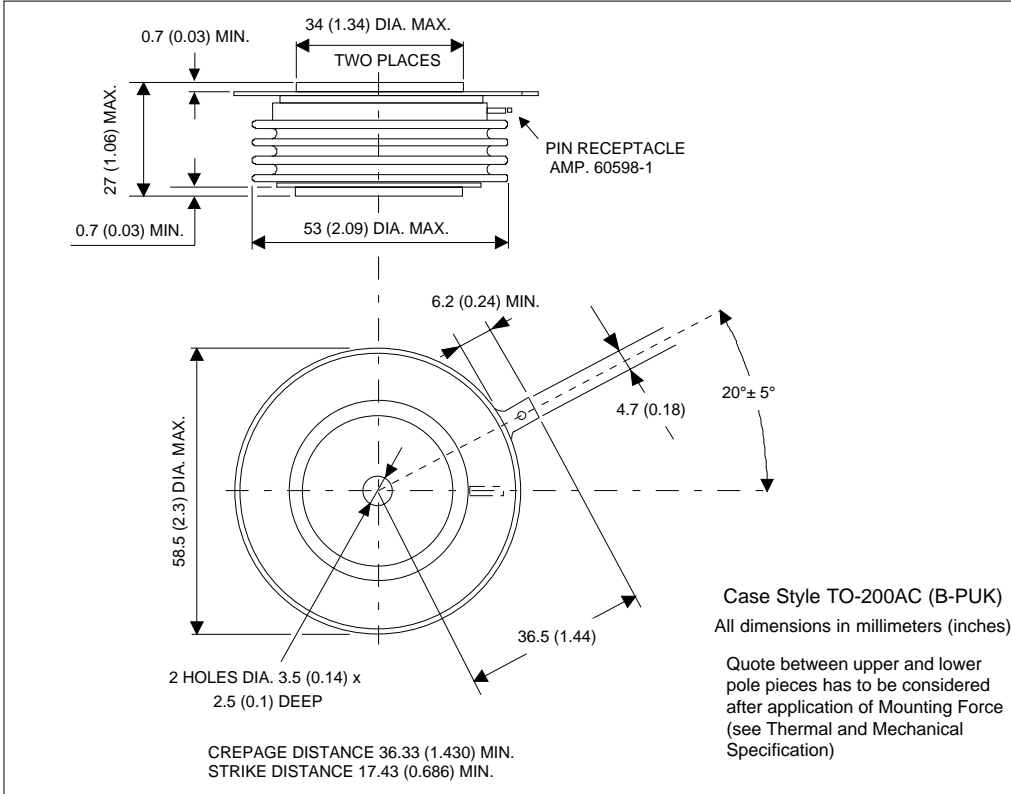

Fig. 1 - Current Ratings Characteristics

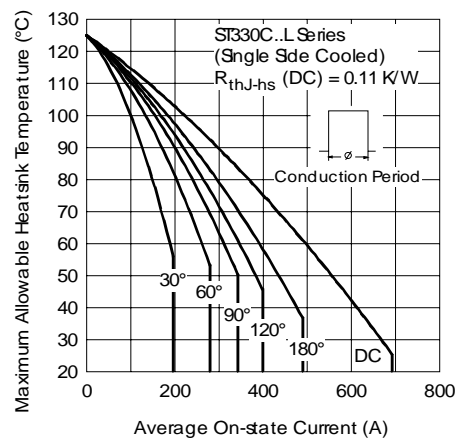

Fig. 2 - Current Ratings Characteristics

ST330C..L Series

Bulletin I25154 rev. D 04/03

International
IRF Rectifier

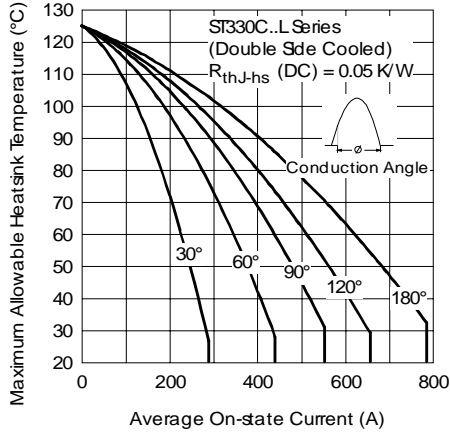

Fig. 3 - Current Ratings Characteristics

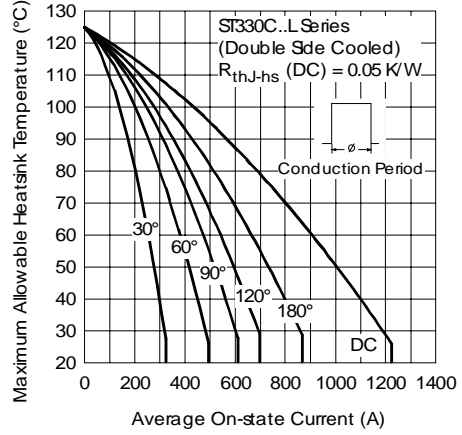

Fig. 4 - Current Ratings Characteristics

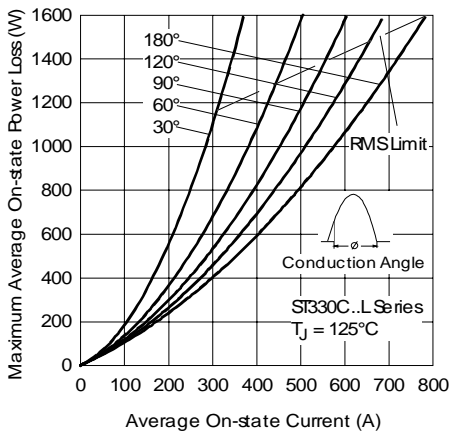

Fig. 5 - On-state Power Loss Characteristics

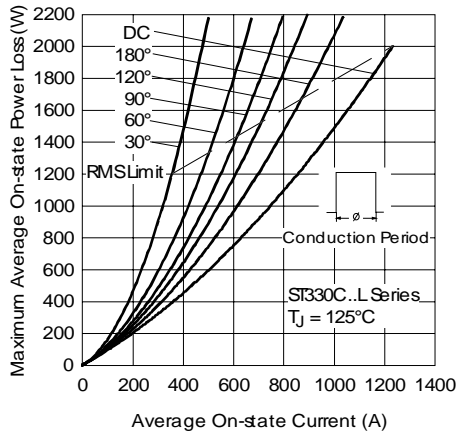

Fig. 6 - On-state Power Loss Characteristics

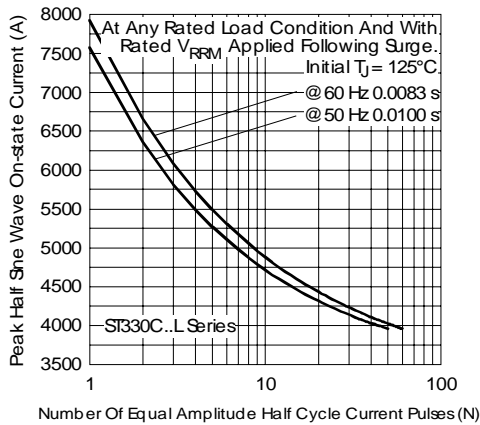

Fig. 7 - Maximum Non-Repetitive Surge Current Single and Double Side Cooled

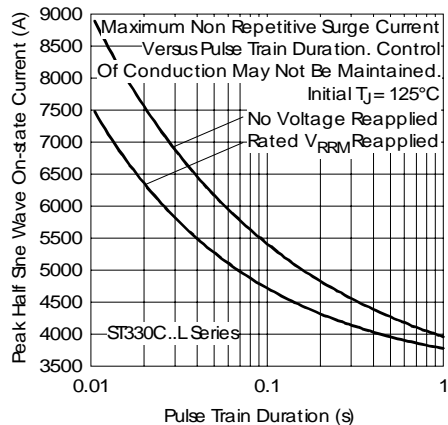

Fig. 8 - Maximum Non-Repetitive Surge Current Single and Double Side Cooled

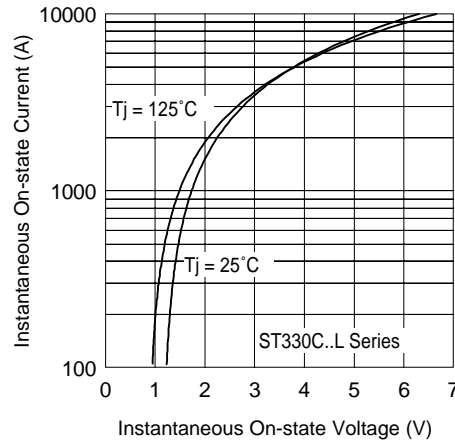

Fig. 9 - On-state Voltage Drop Characteristics

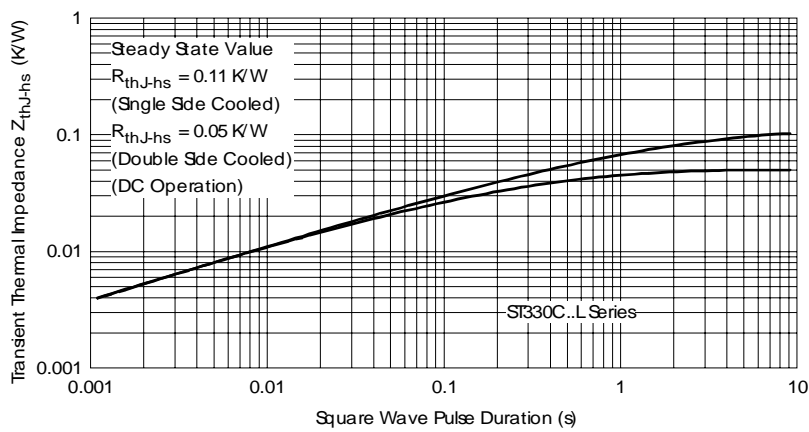

Fig. 10 - Thermal Impedance Z_{thJ-hs} Characteristics

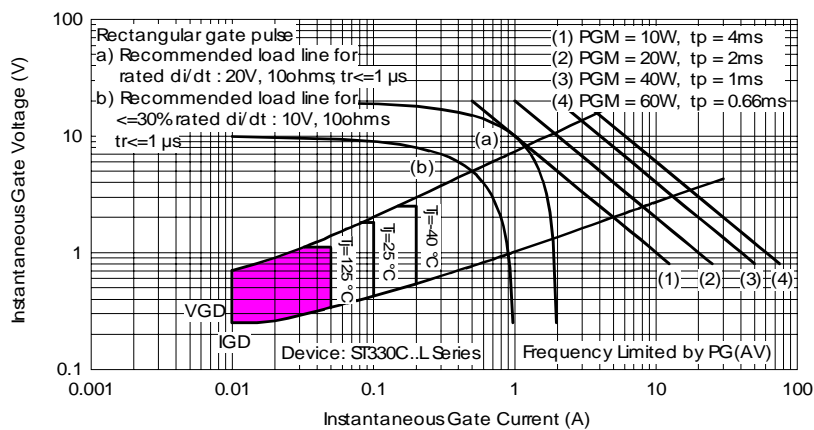

Fig. 11 - Gate Characteristics

ST330C..L Series

Bulletin I25154 rev. D 04/03

International
IOR Rectifier

Data and specifications subject to change without notice.
This product has been designed and qualified for Industrial Level.
Qualification Standards can be found on IR's Web site.

International
IOR Rectifier

IR WORLD HEADQUARTERS: 233 Kansas St., El Segundo, California 90245, USA Tel: (310) 252-7105
TAC Fax: (310) 252-7309
Visit us at www.irf.com for sales contact information. 04 /03